













### TABLE OF CONTENTS

<b>1. INTRODUCTION</b> .....	<b>4</b>	<b>5.1</b> Reviewing the Alarm / Tamper Memory Content....	<b>11</b>
<b>1.1</b> Overview.....	<b>4</b>	<b>5.2</b> Reviewing Trouble Information.....	<b>11</b>
<b>1.2</b> System Features.....	<b>5</b>	<b>5.3</b> Reviewing Co-Existing Memory and Trouble Information.....	<b>12</b>
<b>1.3</b> Terms of the Trade.....	<b>5</b>	<b>5.4</b> Correcting Trouble Situations.....	<b>12</b>
<b>1.4</b> Symbols Used in this Manual.....	<b>5</b>	<b>6. SPECIAL FUNCTIONS</b> .....	<b>12</b>
<b>1.5</b> Control Pushbuttons.....	<b>5</b>	<b>6.1</b> Looking after People Left at Home.....	<b>12</b>
<b>1.6</b> Multi-Function Transmitter.....	<b>5</b>	<b>6.2</b> Emergency Calls for Help.....	<b>13</b>
<b>1.7</b> Why are the Voice Announcements Omitted?.....	<b>6</b>	<b>6.3</b> Remote Control by Telephone.....	<b>13</b>
<b>2. SECURING THE PROTECTED SITE</b> .....	<b>7</b>	<b>6.4</b> Two-Way Voice Communication.....	<b>13</b>
<b>2.1</b> Security-Related Pushbuttons.....	<b>7</b>	<b>6.5</b> Receiving Messages at a Remote Telephone.....	<b>14</b>
<b>2.2</b> Preparing to Arm.....	<b>7</b>	<b>6.6</b> Receiving Messages Via a Pager.....	<b>14</b>
<b>2.3</b> Arming 'AWAY'.....	<b>7</b>	<b>6.7</b> Conducting a Walk Test.....	<b>14</b>
<b>2.4</b> Arming 'HOME'.....	<b>7</b>	<b>7. USER SETTINGS</b> .....	<b>15</b>
<b>2.5</b> Switching from 'HOME' to 'AWAY'.....	<b>7</b>	<b>7.1</b> What are the Settings You Need.....	<b>15</b>
<b>2.6</b> Switching from 'AWAY' to 'HOME'.....	<b>7</b>	<b>7.2</b> Entering the User Settings Menu.....	<b>15</b>
<b>2.7</b> Arming 'Instant'.....	<b>7</b>	<b>7.3</b> Bypassing Zones.....	<b>16</b>
<b>2.8</b> Force Arming.....	<b>8</b>	<b>7.4</b> Reviewing the Bypassed Zone List.....	<b>16</b>
<b>2.9</b> Arming in the 'Latchkey' Mode.....	<b>8</b>	<b>7.5</b> Recalling the Last Bypass Scheme.....	<b>16</b>
<b>2.10</b> Initiating a Panic Alarm.....	<b>8</b>	<b>7.6</b> Programming the 'Follow-me' Telephone No.....	<b>16</b>
<b>2.11</b> Disarming and Stopping Alarms.....	<b>8</b>	<b>7.7</b> Setting the User Codes.....	<b>17</b>
<b>2.12</b> Siren Behavior.....	<b>9</b>	<b>7.8</b> Setting the Voice Options.....	<b>17</b>
<b>3. SPEECH AND SOUND CONTROL</b> .....	<b>9</b>	<b>7.9</b> Setting the Clock.....	<b>17</b>
<b>3.1</b> Speech and Sound Control Pushbuttons.....	<b>9</b>	<b>7.10</b> Setting the Date.....	<b>17</b>
<b>3.2</b> Adjusting the Speech Volume.....	<b>9</b>	<b>8. READING THE EVENT LOG</b> .....	<b>18</b>
<b>3.3</b> Voice ON/OFF.....	<b>9</b>	<b>8.1</b> Event Log Description.....	<b>18</b>
<b>3.4</b> Recording a Message.....	<b>10</b>	<b>8.2</b> Reading Procedure.....	<b>18</b>
<b>3.5</b> Message Playback.....	<b>10</b>	<b>9. MAINTENANCE</b> .....	<b>18</b>
<b>3.6</b> Chime ON/OFF.....	<b>10</b>	<b>9.1</b> Replacing the Backup Battery.....	<b>18</b>
<b>4. ELECTRICAL DEVICE CONTROL</b> .....	<b>10</b>	<b>9.2</b> Replacing Batteries in Wireless Devices.....	<b>19</b>
<b>4.1</b> Control Options and Pushbuttons.....	<b>10</b>	<b>9.3</b> Periodic Testing.....	<b>20</b>
<b>4.2</b> Manual Switch-On.....	<b>10</b>	<b>9.4</b> Cleaning the Control Panel.....	<b>20</b>
<b>4.3</b> Manual Switch-Off.....	<b>10</b>	<b>10. PERFORMANCE LIMITS</b> .....	<b>20</b>
<b>4.4</b> Automatic ON/OFF Control.....	<b>11</b>	<b>APPENDIX A. GLOSSARY</b> .....	<b>21</b>
<b>5. READING ALARM MEMORY &amp; TROUBLE DATA</b> .....	<b>11</b>		

### QUICK REFERENCE TO PRIMARY ALARM CONTROL OPERATIONS

<b>Arming AWAY</b> .....	 + [Code]*
<b>Arming AWAY-INSTANT</b> .....	 + [Code]* + 
<b>Arming HOME</b> .....	 + [Code]*
<b>Arming HOME-INSTANT</b> .....	 + [Code]* + 
<b>Arming AWAY-LATCHKEY</b> .....	 + [Code]* + 
<b>Force Arming AWAY</b> (system not ready) .....	 + [Code]* +  (to silence the protest buzz)
<b>Force Arming HOME</b> (system not ready) .....	 + [Code]* +  (to silence the protest buzz)
<b>Disarming and stopping alarms</b> .....	 + [Code]

\* The factory default master code is 1 1 1 1. The code is not required if quick arming has been permitted by the installer.

**Dear Customer,**

Thank you for choosing PowerArt™ - a highly advanced wireless alarm control system produced by Visonic Ltd.

Please note below the installer's telephone number to facilitate obtaining assistance.

**Company Name:** \_\_\_\_\_

**Telephone Number:** \_\_\_\_\_

**Person to Contact:** \_\_\_\_\_

Also please make sure that you have the name and telephone number of the central station your system will report to. If you ever call the central station to ask questions, you should be able to come up with your "ACCOUNT NUMBER" used to identify your alarm system to the central station. Obtain this information from your installer and write it down below.

**Monitoring Station's Name** \_\_\_\_\_

**Telephone Number:** \_\_\_\_\_

**My Account Number:** \_\_\_\_\_

If your system was set by the installer to contact private telephone numbers, note down the 3 telephone numbers that your installer programmed to be called besides the "follow-me" number:







**Phone No. 1:** \_\_\_\_\_

**Phone No. 2:** \_\_\_\_\_

**Phone No. 3:** \_\_\_\_\_

**Phone No. 4:** Follow-me (see paragraph 7.3 )

### SUMMARY OF AUDIBLE SIGNALS

Sound	Sequence	Significance
 (-)	Once only	A key in the keypad has been pressed
 (- -)	Once only	The system reverts automatically to the previous state
 (- - -)	Once per minute	A state of trouble is presently being detected
 (- - - ———)	Once only	Command / operation carried out successfully
 (———)	Once only	Illegal command - wrong code - refusal to obey
Slow beeping at first (- - - - -) and faster beeping throughout the last 10 seconds (- - - - - - - - - -).	Once only, throughout a time delay determined by the installer.	Exit delay warning upon arming the system; also entry delay warning upon entry via a delay zone.
(———)	Continuous tone upon arming (lasts until the last 10 seconds of the exit delay)	"Forced arming" is taking place while the system is "not ready" (the tone stops by clicking the arming button once more).
 (ding-dong)	Once only	A chime zone is being disturbed (while the system is in the disarmed state).

### LUMINOUS INDICATOR SIGNALS

LED	Behavior	Significance
<b>ARM</b>	Lights steadily	The system is in the armed state (AWAY MODE)
	Flashes	The system is in the armed state (HOME MODE)
	No light	The system is presently in the disarmed state
<b>TROUBLE</b>	Lights steadily	A state of trouble is presently being detected
	No light	No trouble - all is well.
<b>CHIME</b>	Lights steadily	The chime function is active - chime zones will chime when disturbed
	No light	The chime function is inactive - chime zones will not chime when disturbed
<b>POWER</b>	Lights steadily	AC power is supplied to the control panel
	No light	The system is operating on backup battery power.

## SIREN SIGNALS

Alarm Type	Graphic Representation of Signal	Verbal Description of Signal
Burglar / 24 hour/ Panic	—————	ON continuously
Fire	--- --- --- --- .....	ON - ON - ON - pause - ON - ON - ON - pause .....
Test	— (both external and internal sirens)	ON for 2 seconds (once)

## USEFUL HINTS FOR POWERART™ USERS

### Important for UL listed installations:

This system is suitable for Grade A household burglary applications.

Wireless smoke detector MCT-423 is not UL listed and can not to be used in UL approved installations.

**Stopping an alarm:** When the alarm sounds - press the DISARM (⏏) button on your key-ring transmitter or press  on the keypad and then enter your access code (1 1 1 1 by default).

**Stopping trouble beeps:** When trouble occurs in the system, the TROUBLE indicator on the front panel will light, and a sequence of 3 beeps will sound once per minute. If you do not wish to eliminate the trouble immediately and the beeps are bothersome, press the DISARM (⏏) button on your key-ring transmitter, or press  on the keypad and then enter your access code (1 1 1 1 by default). This will silence the buzzer for 4 hours, after which the trouble beeps will resume sounding. Be advised, however, that in any case the trouble beeps are silenced during night hours.

**Perimeter and interior zones versus 24-hour zones:** Most of the protection sensors in your system are linked to perimeter and interior zones. These zones **trigger** alarms while the system is in the **armed** state and **do not trigger** alarms while the system is in the **disarmed** state. Other sensors are linked to 24-hour zones which trigger alarms irrespective of arming/disarming.

**Arming while perimeter zones are not secured (doors and/or windows are open):** Your display will read "NOT READY" if a protected door or window is open. You can find out which zone is "not ready" by clicking the <SHOW/OK> button. You can eliminate the problem by closing the door/window. If you choose not to do so, check with your installer whether he has permitted automatic bypass (deactivation) of any zone that is not secured upon termination of the exit delay (a voice message will announce that "Forced Arming" is under way). Bypassed zones will not be protected throughout the arming period.

Conversely, if you want to bypass a zone intentionally, leave the door or window open and arm the system (a voice message will announce that "Forced Arming" is under way).

**Gaining access to 24-hour zones:** If you wish to access a sensor defined as a 24-hour zone without causing an alarm:

- Click <NEXT> - the display will read: **NORMAL MODE.**
- Click <NEXT> again - the display will read: **USER SETTINGS.**
- Click <SHOW/OK> - the display will read: **ENTER CODE \_\_\_\_.**
- Key your secret 4-digit <User Code> - the buzzer will play the "happy tune" (- - - —).

You have 4 minutes during which the 24-hour sensor can be opened and accessed. **When the 4 minutes are up, the system will automatically revert to the normal mode.**

**Canceling accidental alarms:** Upon alarm, the internal sounder is activated first for a limited period of time (set by the installer). Then the external siren starts and the event is reported to the central monitoring station. If you accidentally cause an alarm, you may simply disarm the system before the external siren starts - the alarm will not be reported.

If you cause an alarm accidentally and the external siren has already started - you can still disarm the system within a time limit set by the installer (1 to 15 minutes, as desired). If you manage to disarm on time, a **CANCEL ALARM** message will be automatically sent to the central monitoring station.

**Failing to exit before the exit delay expires:** If you exit the protected site after the exit delay expires (the exit delay beeps stop), the system will interpret this as if you just entered. The entry delay countdown will begin and the entry delay beeps will sound. To prevent an alarm, you must disarm the system before the entry delay expires.

**Unauthorized entry took place while you were away:** If you hear alarm sirens when you are about to re-enter the premises, and lights which should be off are on - an intruder may still be inside or another event may have occurred. Do not confront the intruder - remain outside and call the emergency services.

# 1. INTRODUCTION

## 1.1 Overview

The PowerArt™ is a wireless alarm control system that provides protection against burglary, fire and tampering. In addition, it can be used to control lights and electrical appliances within your household and/or to monitor the activity of disabled or elderly people left at home. Status information is presented visually and verbally, and in most cases a recorded voice prompts you to take correct action.

The PowerArt™ is governed by a control panel (Figure 1) designed to collect data from various sensors that are strategically located within and along the perimeter of the protected site (Figure 2).

In the **disarmed state**, the system provides you with visual and verbal status information, and initiates an alarm if smoke is detected or upon disturbance in a 24-hour zone (a zone which is active 24-hours a day).

In the **armed state**, the system will initiate an alarm upon detection of disturbance in any one of the armed zones.

You will need a 4-digit security code to master the system, and you can authorize 7 other persons to use the system by providing them with their own security codes. Moreover, you can obtain up to 8 multi-function key-ring transmitters that will allow you and other users to control major functions without approaching the control panel.

The system identifies a wide range of events - alarms, attempts to tamper with sensors and several types of trouble. Events are automatically reported via the public telephone network to central monitoring stations (in digital form) and to private telephones (in plain language). The person receiving such a message is expected to investigate the event and act accordingly.

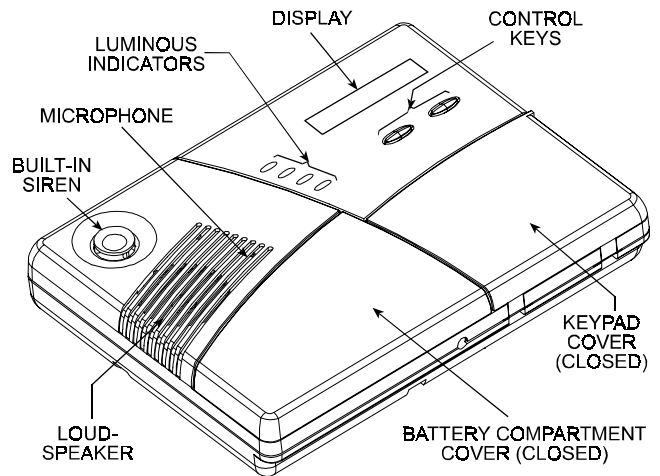

Figure 1. Control Panel with Covers Closed

**IMPORTANT! All you need to know to secure your premises can be found in Section 2 of this manual. If you are not familiar with some of the terms used here, refer to Appendix A at the end of this guide.**

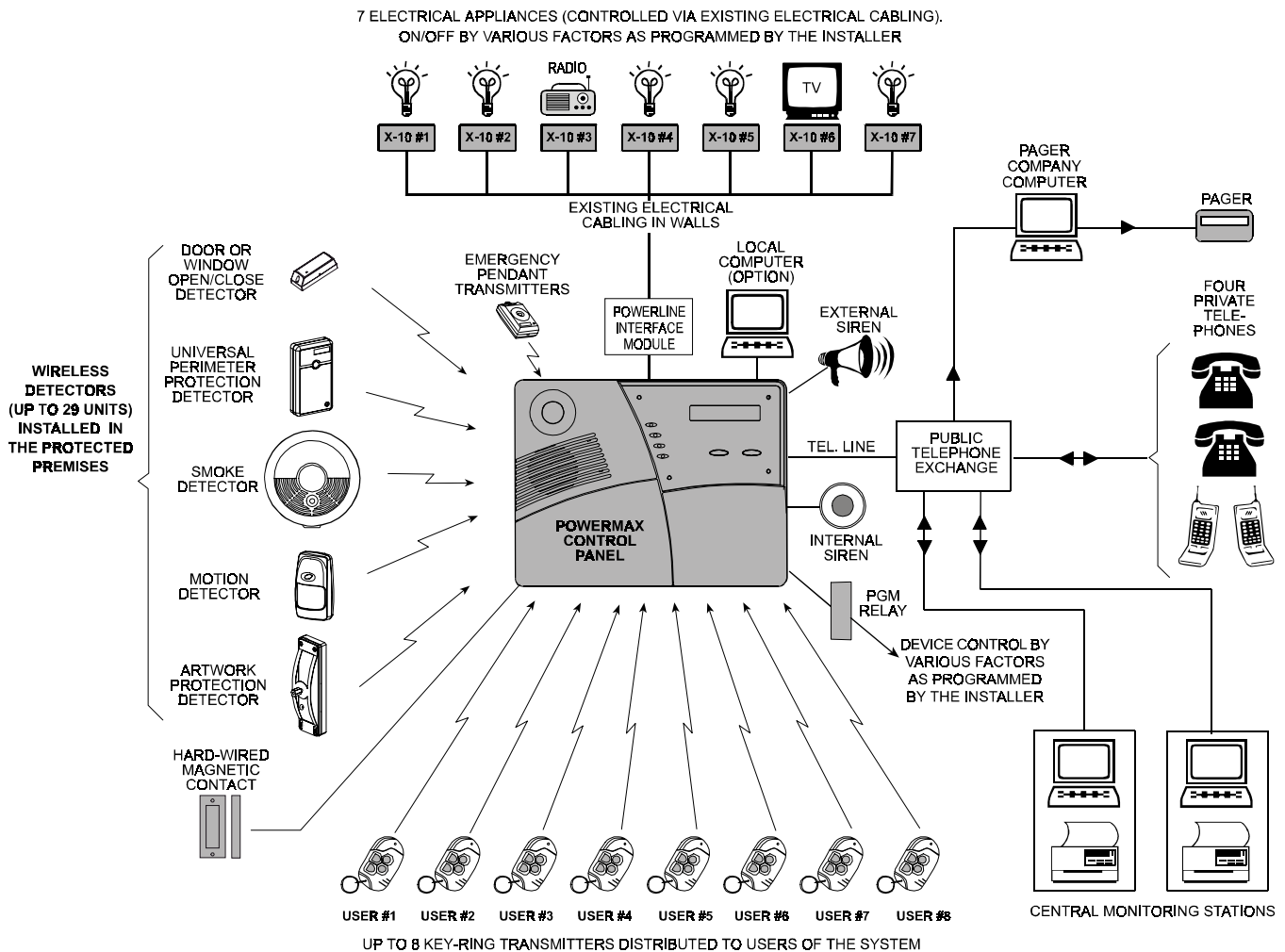

Figure 2. Typical System Configuration

## 1.2 System Features

Your PowerArt™ offers a large number of unique features:

- **30 individually-named zones** : Each protected zone is identified not only by number but also by name (ask your installer to assign appropriate names to your zones).
- **Multiple arming modes:** AWAY, HOME, AWAY-INSTANT, HOME-INSTANT and LATCHKEY.
- **Liquid crystal display (LCD):** Plain-language status information and prompts are displayed on the front panel in large, clear letters.
- **Real-time clock:** The present time is visible on the right side of the display.
- **Various reporting destinations:** Events are reported automatically to central monitoring stations, private telephones of your choice and even to a pager.
- **Selective reporting:** Your installer can determine what type of event will be reported to which destination.
- **Latchkey mode:** An automatic "Latchkey" message is sent to chosen telephones if the system is disarmed by a "latchkey" user (a junior family member, for instance).
- **Spoken announcements and instructions:** Status-dependent, pre-recorded verbal messages are heard over the built-in loudspeaker (if the voice prompts are enabled - see Para. 7.5).
- **Message exchange:** Before leaving the premises, you may record a short verbal message for other users of the system who may arrive later. Upon arrival, you can listen to verbal messages left by others for you.
- **Keypad and wireless control:** Full control from the keypad; major functions can be carried out by pressing buttons on hand-held miniature transmitters.
- **Access from remote telephones:** You may access the PowerArt™ from a remote telephone and Arm/Disarm it or receive system status information.
- **Numerical keys serve as function keys:** In the disarmed state, numerical keys are used to control various system functions. A simple icon on each key identifies the task of that key.
- **Electrical device control:** Lights and electrical appliances can be controlled if optional X-10 modules are used. The electrical cabling network of the building carries the control signals. Your installer will determine the control means in accordance with your needs.
- **PGM remote control:** Gate control mechanisms, courtesy lights and various other devices can be switched on and off via a special PGM (programmable) output. Your installer will determine the control means, in accordance with your needs.
- **Data Retrieval:** You can get status information, trouble information and review memorized alarm events - visually and verbally.
- **Looking after elderly, physically handicapped and infirm individuals:** The system can be programmed to monitor activity within the protected area and send out an alert message if the person under surveillance remains still for too long.
- **Distress calls:** Miniature pushbutton transmitters dealt out to specific individuals may be used for sending emergency calls for help.
- **Disarming under duress:** If a user is forcibly compelled to disarm the system, he can use a special code that disarms the system apparently as usual, but sends a silent alarm to the central station (see Para. 2.11F).
- **System supervision:** All wireless detectors within the protected site send periodic supervision messages. If

such a message is overdue, the PowerArt™ displays an 'inactivity' trouble message. Your installer can disable this feature if so desired.

- **Battery supervision:** You do not have to worry about 'dead' batteries. The PowerArt™ displays a 'Low Battery' message whenever a battery in a wireless device is found to be near the end of its useful life.

## 1.3 Terms of the Trade

Better understanding of your system is assured if you take time to read the definitions in **APPENDIX A** at the end of this manual. However, if this is not your first alarm system, then simply read on.

## 1.4 Symbols Used in This Manual

Symbol	Significance
	<b>Press key:</b> Press the key indicated by the finger or enter the digits indicated by the finger.
	<b>Security code:</b> 1 1 1 1 by default.
	<b>Failure:</b> "Sad Melody" (———).
	<b>Success:</b> "Happy Melody" (- - - ——).
	<b>Single beep (-):</b> Occurs upon pressing any key.
	<b>Double beep(- -):</b> Indicates automatic time-out.
	<b>Triple beep (- - -):</b> Once per minute, indicates a state of trouble.
	<b>Buzzer alarm:</b> buzzer sounds continuously.
	<b>Exit/Entry delay warning:</b> Slow beeping at first (- - - - -) and faster beeping throughout the last 10 seconds (- - - - -).
	<b>Flashing cursor.</b>
	<b>Indicator is ON:</b> The indicator named near this symbol illuminates.
	<b>Indicator is flashing:</b> The indicator named near this symbol flashes.
	<b>Indicator is extinguished:</b> The indicator named near this symbol extinguishes.
	<b>Spoken announcement</b> over the loudspeaker

## 1.5 Control Pushbuttons

When the keypad cover is closed, as shown in Figure 1, only two pushbuttons are visible - the top panel controls:

Key	Task
	Advance from item to item within a given menu.
	Review status messages one by one and also select a displayed option.

With the keypad uncovered (see Figures 4 and 5), the special-function keys are visible. The tasks of these keys are explained in the relevant sections of this guide.

## 1.6 Multi-Function Transmitter

Your system responds to signals sent by a 4-button miniature 'keyfob' transmitter (MCT- 234) that you and other users can carry. The function of each key is indicated in Figure 3 on the right. Your installer can program the AUX (auxiliary) button to perform various tasks, as required.



Figure 3. Keyfob Transmitter

- A. Controlling a gate or another electrical device:** Pressing the AUX button will open/close an electrically-controlled gate, or will control a chosen electrical device within or around your business or residence.
- B. Arming the system in the INSTANT mode (without an entry delay):** Pressing the AUX button immediately after arming, while the exit delay is in progress, will cause the system to be armed without an entry delay. This means that entering the protected premises via any zone will trigger an immediate alarm. You and other holders of keyfob transmitters will have no problem, because you can disarm the system before entering by pressing the DISARM (1) button on your transmitter before entry.
- C. Getting status information:** Upon pressing the AUX button on your transmitter, the voice module will

announce the status of the system over the built-in loudspeaker.

### 1.7 Why are the Voice Announcements Omitted in this Manual?

The PowerArt's voice module helps you control the system at close range and also from a remote telephone. The pre-recorded voice responds to your commands by announcing what the system is doing and by prompting you to perform certain actions. It also announces alarms and troubles, and identifies the source of each.

The pre-recorded plain language announcements made by the voice module are quite clear and self explanatory. We therefore omitted the spoken text in the following sections of this guide and focused attention on visual display and sounder beeps. This way we managed to keep the user guidance brief and concise.

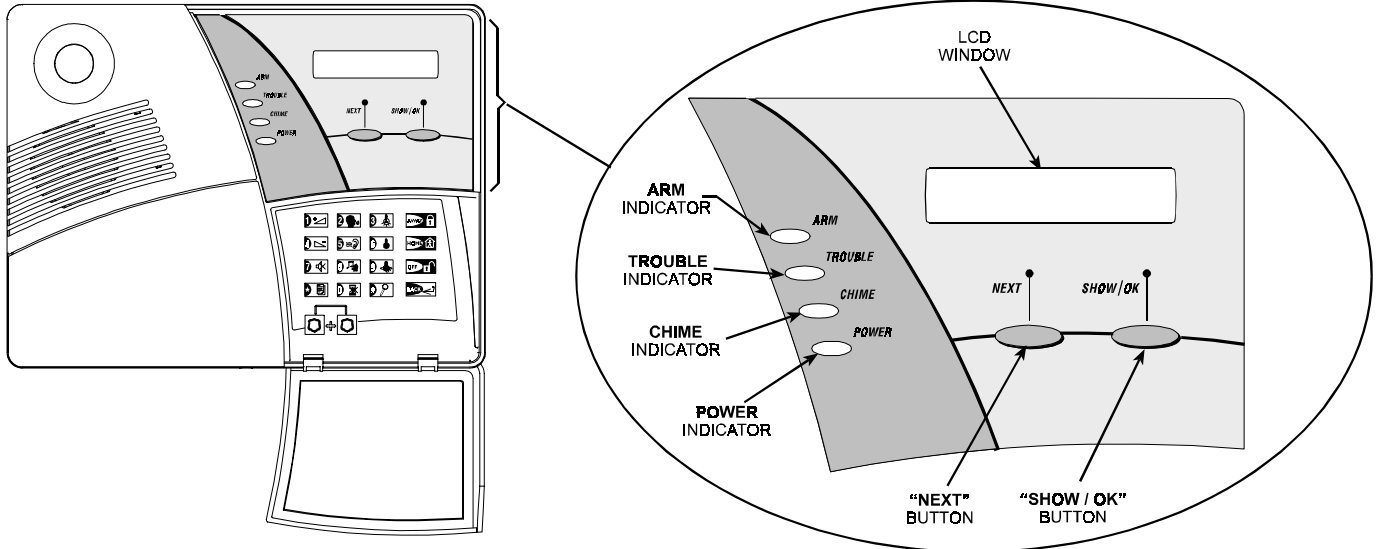

Figure 4. Top Panel Controls and Indicators

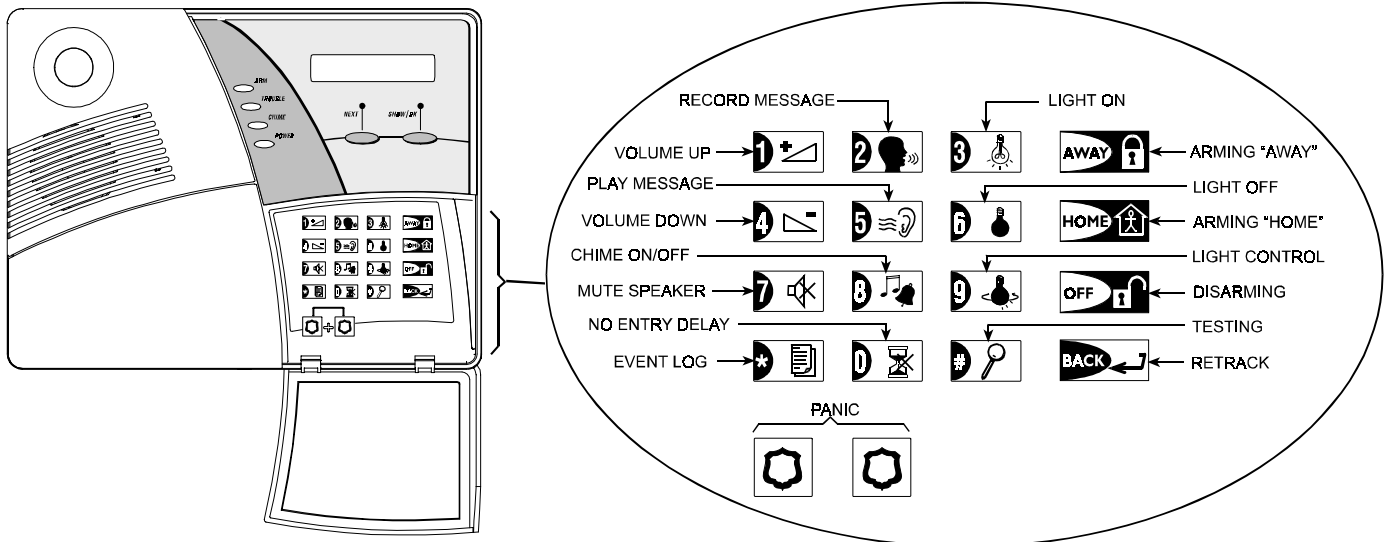

Figure 5. Keypad Button Assignments - Quick Reference

## 2. SECURING THE PROTECTED SITE

### 2.1. Security-Related Pushbuttons

Key	Function
	Arming when nobody is at home
	Arming when people remain at home
	Canceling the entry delay upon arming ('AWAY-INSTANT' or 'HOME-INSTANT')
	Disarming the system and stopping alarms
	Testing the system (see Para. 6.7).

### 2.2 Preparing to Arm

Before arming, make sure that **READY** is displayed:

**READY** HH : MM

If **Ready** is displayed, all zones are secured, and you may arm the system any way you choose.

If at least one zone is open (disturbed), the display will read:

**NOT READY** HH : MM

If **NOT READY** is displayed, click to review the numbers and names of all open zones one by one.

Let us assume that **zone 2** (ROOM 1) and **zone 13** (ROOM 2) are open. To investigate, proceed as follows:

Action	Resultant Display	Sound
	<b>NOT READY</b> HH : MM	
	<b>ROOM 1</b> ↻ (alternating) ↻ <b>Z 2 OPEN</b>	
	<b>ROOM 2</b> ↻ (alternating) ↻ <b>Z 13 OPEN</b>	
None (see note below)	↓ (after 10 seconds) ↓ <b>NOT READY</b> HH : MM	

**Note:** To quit immediately at any stage, press .

It is highly recommended to fix the open zone(s), thus restoring the system to the state of "ready to arm". **If you do not know how to do this, consult your installer.**

**IMPORTANT!** All arming procedures below are based on the assumption that **quick arming** has been enabled by the installer. If **quick arming** is disabled, the PowerArt will prompt you to enter your security code before arming.

### 2.3 Arming 'AWAY'

If the system is **READY**, proceed as shown:

Action	Resultant Display	Sound
	<b>ARMING AWAY</b>	
Vacate the premises	↓	
	<b>PLEASE EXIT NOW</b>	
	↓ (Exit Delay) ↓	
	<b>AWAY</b>	
<b>ARM</b> lights steadily throughout the armed state		

### 2.4 Arming 'HOME'

If all perimeter zones are **READY**, and quick arming is allowed, proceed as shown:

Action	Resultant Display	Sound
	<b>ARMING HOME</b>	
Move to interior zone	↓ (Exit Delay) ↓	
	<b>HOME</b> HH : MM	
<b>ARM</b> flashes throughout the armed state		

### 2.5 Switching from 'HOME' to 'AWAY'

Do not disarm the system - just press . The response will be the same as in Para. 2.2. Vacate the premises before the exit delay expires.

### 2.6 Switching from 'AWAY' to 'HOME'

Do not disarm the system - just press . Since this operation reduces the security level, the PowerArt™ will ask you to key in your master or user code, thus making sure that you are an authorized user.

Action	Resultant Display	Sound
	<b>CODE</b> █ █ █ █	
Move to interior zone	<b>ARMING HOME</b>	
	↓ (Exit Delay) ↓	
	<b>HOME</b> HH : MM	
<b>ARM</b> flashes throughout the armed state		

If an alarm occurred while the system was armed in the **AWAY** mode, the display will respond differently:

Action	Resultant Display	Sound
	<b>CODE</b> █ █ █ █	
Move to interior zone	<b>ARMING HOME MEM</b>	
	↓ (Exit Delay) ↓	
	<b>HOME</b> HH : MM	
	↻ (alternating) ↻	
	<b>HOME</b> MEMORY	
<b>ARM</b> flashes throughout the armed state		

### 2.7 Arming 'Instant'

You may arm **AWAY** or **HOME** without an entry delay - any detection in any zone will trigger an immediate alarm. If you wish to arm **AWAY-INSTANT**, proceed as follows:

Action	Resultant Display	Sound
	<b>ARMING AWAY</b>	
Vacate the premises		
	<b>ARMING INSTANT</b>	
	↻ (alternating) ↻	
	<b>PLEASE EXIT NOW</b>	
	↓ (Exit Delay) ↓	
	<b>AWAY</b>	
<b>ARM</b> lights throughout the armed state		

If you wish to arm HOME-INSTANT, proceed as follows:

Action	Resultant Display	Sound
	ARMING HOME	
	ARMING INSTANT (alternating)	
Go to an interior zone	↓ (Exit Delay) ↓ ARM HOME HH : MM (alternating) ARM HOME INSTANT	
ARM indicator flashes throughout the armed state		

## 2.8 Forced Arming

Forced arming allows you to arm the system even though one zone or several zones are disturbed, and the NOT READY message is displayed.

Automatic forced arming only works if the installer allowed this option while programming your system. Disturbed zones will be bypassed - they will not be armed. **The protected site will not have maximum protection.**

**Note:** When forced arming is carried out, the buzzer "protests" by emitting a continuous tone during the exit delay until the last 10 seconds of the delay. You can silence this signal by pressing the arming button again.

Forced arming "AWAY" proceeds as follows:

Action	Resultant Display	Sound
	NOT READY TO ARM	
	ARMING AWAY ↓ PLEASE EXIT NOW	
 (to mute the buzzer)	↓ (Exit Delay) ↓ AWAY	
ARM indicator lights throughout the armed state		

Forced arming HOME proceeds as follows:

Action	Resultant Display	Sound
	NOT READY TO ARM	
 (to mute the buzzer) Go to an interior zone	ARMING HOME ↓ (Exit Delay) ↓ HOME HH : MM	 
ARM indicator flashes throughout the armed state		

## 2.9 Arming in the Latchkey Mode

This mode is useful for a parent at work who wants to be sure that his children have returned from school and have disarmed the system. Arming in the "latchkey" mode means that a special "latchkey" message will be sent out when the system is disarmed by a "latchkey user".

Latchkey users are holders of user codes 5 through 8 or users of Keyfob transmitters 5 through 8. The latchkey message is considered an **alert** and not an alarm, and is therefore sent to the private telephones programmed by the user as targets for alert messages.

Latchkey arming is possible only when you arm "AWAY".

To arm in the Latchkey mode, proceed as follows:

Action	Resultant Display	Sound
	ARMING AWAY	
 (within 2 seconds)	ARMING LATCHKEY (alternating)	
Vacate the premises	PLEASE EXIT NOW ↓ (Exit Delay) ↓ AWAY	
ARM indicator lights throughout the armed state		

## 2.10 Initiating a Panic Alarm

You can generate a panic alarm manually in the disarmed and armed states alike. The sequence will be as shown:

Action	Resultant Display	Sound
 (pressed simultaneously)	PANIC ALARM Then, if or when the system is in the disarmed state: READY HH : MM (alternating) READY MEMORY	<b>Siren</b>

**Note:** if you are using a key-ring transmitter, press both AWAY and HOME buttons simultaneously for 2 seconds.

## 2.11 Disarming and Stopping Alarms

Disarming the system stops the siren before it stops automatically. This is true, irrespective of whether the alarm was initiated in the armed or the disarmed state.

After disarming, different displays may appear, depending on the current status of the system:

**A. Disarming - no events:** After an uneventful armed term, the disarming operation will progress as shown:

Action	Resultant Display	Sound
	CODE [ ]	
	READY HH : MM	 ↓ 
ARM indicator extinguishes		

**B. Disarming after alarm, with all zones ready:**

If the zone that alarmed in the armed state is back to normal, the disarming operation will progress as shown:

Action	Resultant Display	Sound
	CODE [ ]	
	READY HH : MM (alternating) READY MEMORY	 ↓ 
ARM indicator extinguishes		

To read the alarm memory, refer to Section 5. The "MEMORY" message will disappear only upon re-arming the system.

**C. Disarming after an alarm, with one zone still disturbed:** If the zone that alarmed in the armed state is still disturbed, the disarming operation will progress as shown:



Action	Resultant Display	Sound
	CODE [ ] [ ] [ ] [ ]	
	NOT READY HH : MM ⤴ (alternating) ⤵	
	NOT READY MEM	
ARM indicator extinguishes		

To read the alarm memory, refer to Section 5. The "MEMORY" message will disappear only when you rearm the system.

If you do not know how to return the disturbed zone to normal, consult your installer.

**D. Disarming with the system in a state of trouble.** If trouble is detected in the armed state, the TROUBLE indicator on the front panel will light and the disarming operation will progress as shown:

Action	Resultant Display	Sound
	CODE [ ] [ ] [ ] [ ]	
	READY HH : MM ⤴ (alternating) ⤵	
	READY TRBL	
ARM extinguishes and  sounds once per minute		

To find out what kind of trouble is being sensed, see Section 5. The TRBL display will disappear, the TROUBLE indicator will extinguish and the trouble beeps will stop upon eliminating the cause for trouble.

**E. Disarming after an alarm, with the system in a state of trouble.** The TROUBLE indicator on the front panel will light. If the zone that alarmed while the system was in the armed state is back to normal, the disarming operation will progress as shown:

### 3. SPEECH AND SOUND CONTROL

#### 3.1 Speech and Sound Control Push-buttons

The sound and speech-related functions offered by the PowerArt™ are controlled with the keypad, as detailed in the following list.

Key	Function
	Increasing the loudness of spoken messages
	Decreasing the loudness of spoken messages
	Enabling / disabling the loudspeaker
	Recording a spoken message for other users of the alarm system
	Listening to a recorded message left by another user of the alarm system
	Enabling / disabling the chime function in chime zones

#### 3.2 Adjusting the Speech Volume

The following diagram shows how to increase the loudness by clicking the <1> key (assuming that the volume was at minimum to begin with).

Action	Resultant Display	Sound
	CODE [ ] [ ] [ ] [ ]	
	READY HH : MM ⤴ (alternating) ⤵	
	READY TRBL	
	⤴ (alternating) ⤵	
	READY MEMORY	
ARM extinguishes and  sounds once per minute		

To find out which zone alarmed and what kind of trouble is being sensed, see Section 5. The TRBL display will disappear, the TROUBLE indicator will extinguish and the trouble beeps will stop upon eliminating the cause for trouble. The MEMORY message will disappear only upon rearming the system.

**F. Disarming under Duress.** If you are forcibly compelled to disarm the system, enter the default duress code (2580) or another code set by the installer. Disarming will take place normally but a silent alarm will be transmitted to the central station.

#### 2.12 Siren Behavior

**Continuously ON** when initiated by a burglar zone or a 24-hour zone, and when a user initiates a "panic alarm".

**ON - ON - ON - pause - ON - ON - ON - pause - .....** and so on when initiated by a fire zone (smoke is detected).

If there is nobody around to disarm the system upon alarm and a zone remains "open", the siren will sound for the time duration set by the installer - then will stop for 30 seconds - then will re-sound for the same period of time. These siren cycles will repeat up to the maximum number of cycles permitted by the installer ("swinger shutdown"). The open zone will then be disabled and the siren will stop.

A zone disabled by "swinger shutdown" is re-enabled 24 hours after disabling, or sooner upon arming/disarming (depending on the system's state when the alarm occurred).

Action	Resultant Display	Sound
	VOLUME+ [ ] [ ] [ ] [ ]	
	VOLUME+ [ ] [ ] [ ] [ ] [ ]	
	VOLUME+ [ ] [ ] [ ] [ ] [ ] [ ]	
(max)	VOLUME+ [ ] [ ] [ ] [ ] [ ] [ ] [ ]	

The following diagram shows how to decrease the loudness with the <1> key (assuming that the volume was at maximum to begin with).

Action	Resultant Display	Sound
(max)	VOLUME- [ ] [ ] [ ] [ ] [ ] [ ] [ ]	
	VOLUME- [ ] [ ] [ ] [ ] [ ]	
	VOLUME- [ ] [ ] [ ] [ ]	
	VOLUME- [ ] [ ] [ ]	

#### 3.3 Voice ON/OFF

You can switch spoken announcements on and off by alternate clicking of the <7> key, as shown below.

Action	Resultant Display	Sound
	VOICE ON	♪
	VOICE OFF	♪
	↓	
	READY HH:MM	♪♪

**Note:** The system will maintain the "Voice OFF" state until subsequent selection of "Voice ON".

### 3.4 Recording a Message

You can leave a verbal message for other users of the alarm system. Face the panel, press and keep it pressed. When the display reads **TALK NOW**, start talking. The 5 dark boxes will slowly disappear one by one, from right to left, as shown in the diagram below.

Action	Resultant Display	Sound
(continuously)	RECORD A MESSAGE	♪
Talk ↓	TALK NOW ██████████	None
Talk ↓	TALK NOW ██████████	↓
Talk ↓	TALK NOW ██████████	↓
Talk ↓	TALK NOW ██████████	↓
Talk ↓	TALK NOW ██████████	↓
Stop talking	RECORDING ENDED	↓

Once the last of the boxes disappears (20 seconds later), **RECORDING ENDED** will be displayed.

When you release the button, the display will revert to the normal status-displaying mode, but will also indicate that a message is waiting. For example:

READY	HH:MM
↺ (alternating) ↻	
READY	MSG

To check your own message, listen to it within one minute from the end of recording (see Para. 3.5). This way the **MSG** indication will not be erased.

### 3.5 Message Playback

To listen to a message left by another user of the system:

Click and listen. **PLAY** will be displayed and the message will be played back over the built-in loudspeaker. When the playback ends, the display will revert to the normal status-displaying mode. If more than 1 minute elapsed after recording, the **MSG** indication will disappear.

### 3.6 Chime ON/OFF

You can disable / enable the chime zones by alternate clicking of the <8> key, as shown below:

Action	Resultant Display	Sound
	CHIME ON	♪
	CHIME OFF	♪
	↓	
	READY HH:MM	♪♪

CHIME lights steadily when "chime on" is selected

## 4. ELECTRICAL APPLIANCE CONTROL

### 4.1 Control Options and Pushbuttons

The PowerArt™ allows manual or automatic remote control of up to 7 electrical appliances (lights, radio and TV, tape recorders, fans etc.). This requires an optional X-10 controller and 7 remote X-10 units (see figure 2).

ON / OFF control codes are communicated via the regular household electrical wiring.

While programming the system, your installer determines ON and OFF times for each remote controlled device. He also determines which zone sensors will switch the remote controlled appliances on and off. **However, the decision whether the remote controlled appliances will respond as programmed is up to you** (see table below).

Key	Function
	Manual activation of lights or other household electrical appliances.
	Manual deactivation of lighting or other household electrical appliances.
	Selecting the active automatic control method: <ul style="list-style-type: none"> <li>■ <b>Sensors:</b> Appliances are controlled by sensors (assigned by the installer for this).</li> <li>■ <b>Timer:</b> Appliances are controlled by timer (ON and OFF times are defined by the installer).</li> <li>■ <b>Both:</b> Appliances are controlled by sensors as well as by timer.</li> </ul>

Following are two examples of the benefits gained by using of automatic remote control:

- **Timer Control.** When you are away, timed activation / de-activation of lights, radio and TV simulates the presence of people at home, to deter potential burglars.

- **Zone Control.** Upon disturbance of a perimeter zone, lights are switched on and a tape recorder starts running, playing back a series of dog barks.

### 4.2 Manual Switch-On

You can switch appliances ON as instructed below. This example shows how to switch on the lights controlled by X-10 unit No. 1.

Action	Resultant Display	Sound
	LIGHT ON	♪
	LIGHT ON 1	♪
	↓	
	READY HH:MM	♪♪

The lights controlled by X-10 unit No. 1 are switched on

### 4.3 Manual Switch-Off

You can switch appliances OFF as instructed below. This example shows how to switch off the lights controlled by X-10 unit No. 1.

Action	Resultant Display	Sound
	LIGHT OFF	♪
	LIGHT OFF 1	♪
	↓	
	READY HH:MM	♪♪

The lights controlled by X-10 unit No. 1 are switched off

## 4.4 Automatic ON/OFF Control





You can select two of four options:

- By Timer ON
- By timer OFF
- By sensor ON
- By sensor OFF

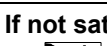
The presently active options are shown with a dark box (■) at the far right. You may view the two other options by clicking <9>.

A presently inactive option is shown without a dark box at the far right. The dark box will appear if you click <OK> while the option is displayed. The ☺ represents the "Happy Tune" - successful saving of a new option.

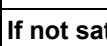
Action	Resultant Display	Sound
	BY TIMER ON ■ (if this is the default)	♪
 If not satisfied -	BY TIMER OFF	♪

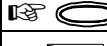
 If satisfied -	BY TIMER OFF ■	♪
	BY TIMER OFF ■	☺
	BY SENSOR ON ■ (if this is the default)	♪
 If not satisfied -	BY SENSOR OFF	♪
	BY SENSOR OFF ■	♪
	BY SENSOR OFF ■	☺
	READY HH : MM	♪

## 5. READING ALARM MEMORY AND TROUBLE DATA

### 5.1 Reviewing the Alarm / Tamper Memory Content

The PowerArt™ retains in its memory alarm and "tamper" events that occurred during the last arming period.

**Note:** Alarms enter the memory only after expiry of the "abort period" (see Appendix A). This means that if you disarm the system immediately - before the abort period expires - there will be no memory indication.

#### A. Alarm / Tamper Indications

When the memory contains at least one event and the system is in the disarmed state, a flashing MEMORY message will be displayed as exemplified:

READY HH : MM  
⤵ (alternating) ⤴

READY MEMORY

or, if the system is not ready for arming -



NOT READY HH : MM  
⤵ (alternating) ⤴

NOT READY MEMORY

#### B. Investigating Alarm/Tamper Data



You can review the memory content, by clicking the SHOW/OK button.

**EXAMPLE 1:** An alarm was triggered because the garage door - zone No. 12 - opened **but then re-closed**. In addition, the bedroom motion detector - zone No. 7 - sent a "Tamper" message because its cover had been removed.

Action	Resultant Display	Sound
	READY HH : MM	🔔
	Z 1 2 ALARMED ⤵ (alternating) ⤴ ROOM 1	🔔
	Z 0 7 TAMPERS ⤵ (alternating) ⤴ ROOM 2	🔔

In response to additional clicking of the <SHOW/OK> button, the display will either show details of other events retained in memory (if any), or will revert to its initial state (see A above).

**EXAMPLE 2:** An alarm was triggered because the garage door - zone No. 12 - opened, but **was left open**.

Action	Resultant Display	Sound
	NOT READY HH : MM	🔔
	Z 1 2 ALARMED ⤵ (alternating) ⤴ ROOM 1	🔔
	Z 1 2 OPEN ⤵ (alternating) ⤴ ROOM 1	🔔

**Remember!** The memory indication and content are cleared upon the next arming of the system.

### 5.2 Reviewing Trouble Information

#### A. Trouble Indications

If TRBL flashes in the display, the TROUBLE indicator illuminates, and 3 beeps are sounded once per minute, you will have to investigate the system in order to find out the origin and type of trouble at hand. The states of trouble can be divided into **sensor / transmitter troubles** and **system troubles**.

#### SENSOR/TRANSMITTER TROUBLES

- **Sensor inactivity** - no radio signals have been received from a particular sensor throughout a pre-defined period.
- **Low battery** - the battery in a wireless device (sensor or hand-held transmitter) is near the end of its useful life.

#### SYSTEM TROUBLES

- **AC Supply Failure** - the mains power has been cut off and the system is working on backup battery power (this trouble is reported 5 minutes after its occurrence).
- **System Jammed** - a radio-frequency signal is blocking the channel via which the sensors communicate with the control panel.

- **Communication failure** - A message could not be sent to the central monitoring station or to a private telephone (or a message was sent but was not acknowledged).
- **CPU low battery** - The backup battery within the control panel is weak and must be replaced (see Para. 8-1).
- **CPU tamper** - The control panel is being tampered with.
- **Fuse Trouble** - The siren fuse is burnt out.

**IMPORTANT!** If the trouble beeps bother you, disarm the system (even though it is already disarmed). This will cancel the trouble beeps for 4 hours.

## B. Investigating Trouble Sources

In a state of trouble, a flashing TRBL message is displayed as shown in the following examples:

READY HH : MM  
 ⤵ (alternating) ⤴

READY TRBL

or, if the system is not ready for arming -

NOT READY HH : MM  
 ⤵ (alternating) ⤴

NOT READY TRBL

You can review the current troubles one by one, by clicking the **SHOW/OK** button.

**EXAMPLE:** The ROOM 1 - zone No. 9 - has been inactive and the GALLERY 1 sensor - zone No. 15 - has reported a low battery. However, these troubles do not prevent the system from being “ready to arm”.

To investigate the source of trouble, proceed as follows:

Action	Resultant Display	Sound
	READY HH : MM ⤵ (alternating) ⤴	🔊
	Z 0 9 I N A C T I V E ⤵ (alternating) ⤴ R O O M 1	🔊
	Z 1 5 L O W B A T T E R Y ⤵ (alternating) ⤴ G A L L E R Y 1	🔊

In response to further clicking of **<SHOW/OK>**, the display will show details of other troubles (if any), or will revert to the initial alternating displays (see example above).

## 5.3 Reviewing Co-Existing Memory and Trouble Information

If **alarms / tamper events** are retained in the alarm memory and at the same time a state of **trouble** exists, the display will behave as shown below:

READY HH : MM

⤵ (alternating) ⤴

READY MEMORY

⤵ (alternating) ⤴

READY TRBL

or, if the system is not ready to arm -

NOT READY HH : MM

⤵ (alternating) ⤴

NOT READY MEMORY

⤵ (alternating) ⤴

NOT READY TRBL

**Note:** When a voice message is in memory, the **MSG** display will also appear (as shown in Para. 3.4).

To read status information - memory data, open zones and trouble sources (in this order) - click the **<SHOW / OK>** button repeatedly. The memory content will be displayed first, in the same manner shown in Para. 5.1. If the system is not ready, open zone information will follow in the same manner as shown in Para 2.2. Trouble sources will be displayed last, in the same manner shown in Para. 5.2.

## 5.4 Correcting Trouble Situations

The trouble indications (illuminated TROUBLE indicator and flashing TRBL message) are cleared once you eliminate the cause for trouble. **If you do not know how to cope with a trouble situation, report it to your installer and seek his advice.**

**INACTIVITY:** Once an inactive sensor renews its periodical transmissions, the inactivity trouble no longer exists and will no longer be indicated by the control panel.

**LOW BATTERY:** Upon replacing the battery in a wireless device that reported a low battery, the next transmission made by the relevant sensor will include a “battery restored” message, and “low battery” will no longer be indicated by the control panel.

**SYSTEM TROUBLE:** Correction of any one of the system troubles is automatically sensed by the control panel, and the trouble indication is cleared accordingly.

## 6. SPECIAL FUNCTIONS

### 6.1 Looking after People Left at Home

An important characteristic of the PowerArt™ is its ability to function in a mode contrary to the usual behavior of an alarm system. When the system is in the disarmed state (or even when armed “HOME” with perimeter protection only), it can keep track of in-house activity and will report **lack of motion** in interior zones if there is no detection of motion within predetermined time limits.

To use this characteristic, you must ask your installer to program a specific time limit beyond which lack of motion will be reported as a “**not active**” alert.

To make things clear, let us assume that an elderly, sick or handicapped person is left unattended in a protected site.

This person, disabled or sick as he may be, will not stay entirely still for hours. It is only natural that even while being asleep he will turn over in his bed from time to time.

He might also wander into the kitchen to eat or drink, or to the bathroom for other necessities. Upon doing so, the bedroom, bathroom and kitchen motion detectors will detect his movement.

If, for example, the “lack of motion” time limit is set by your installer to 6 hours, a virtual 6-hour clock will carry out a 6-hour “countdown”.

If motion is detected within the 6-hour time frame, the countdown will restart from the beginning (the virtual 6-hour clock will be “reset”) and no alert message will be sent out.

If no motion is detected within the 6-hour time frame in any interior zone, the control panel will send a “**not-active**” alert message to the central monitoring station or to private telephones designated by the installer.

**IMPORTANT!** In addition, you may provide the person confined to interiors with a single-button transmitter for distress situations - see Para. 6.2.

## 6.2 Emergency Calls for Help

Suppose the incapacitated person discussed in Para. 6.1 above has an accident such as falling in the bathtub without being able to get up. It might take hours before the "No Active" alert is sent out, but he (or she) must be assisted much sooner.

Even though the odds for such an accident are not high, it is advisable to provide the disabled person with a miniature single-button transmitter to be carried on the neck like a pendant or to be worn on the wrist like a watch. Pressing the button on this transmitter will cause the PowerArt™ to send an "emergency call" to the central monitoring station or to private telephones designated by the installer.

To make this possible, ask your installer to define one of the 29 zones of the PowerArt™ as an emergency zone, obtain for you one of the transmitters listed below and link this transmitter's ID code to the emergency zone.

The models compatible with PowerArt™ are (see Fig. 6):

**MCT-201** - pendant-type distress transmitter

**MCT-211** - wristwatch-type distress transmitter

**MCT-101** - pocket-type distress transmitter

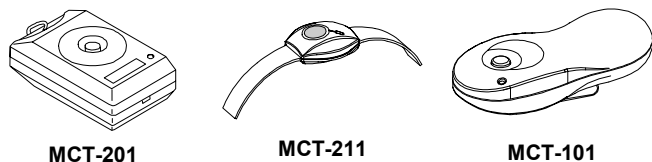

Figure 6. Single-button Emergency Transmitters

## 6.3 Artwork Protection

The PowerArt, with SPD-1000 detectors, can be used for protection of paintings, sculptures and other artworks, in museums, galleries, churches, private artwork collections, etc.

When someone tries to touch or remove the secured object, to which the detector is attached, an identifiable alarm signal is transmitted to the PowerArt. Identifiable signals include: low battery voltage alert, low severity alarm (slight touch) and high severity alarm (repetitive touch, strong touch or removal).

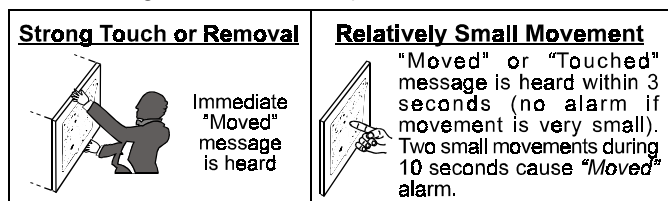

Figure 7. Artwork Protection Alarms

## 6.4 Remote Control by Telephone

The PowerArt™ is designed to respond to your commands at "intimate" range (via the built-in keypad), at short range (via your key-ring transmitter) and at long range (via the public telephone network). Accessing the PowerArt™ from a remote telephone will allow you to perform a large variety of operations, as listed in sub-paragraph B below.

### A. Establishing Telephone Communication with your PowerArt™ Control Panel

When you are away from the protected premises, all you need is a regular telephone set or a cellular telephone to remain in control. Be advised, though, that every action

performed via a remote telephone requires a valid user code - to prevent unauthorized access to the system.

To contact the PowerArt™, proceed as follows:

- Dial the telephone number used by your system, allow the telephone to ring 2 - 4 times and then hang up.
- Wait at least 12 seconds (but not more than 30 seconds) after hanging up and redial the number. This time the PowerArt™ will intercept your call - a shrill signal will sound for 10 seconds. **Press [★] to stop the signal.**

**Note:** The PowerArt™ will respond in a similar way if you dial just once and wait until the telephone rings 11 times.

- You may now command your system (see B below).

**Attention!** If you linger more than 50 seconds without keying a command, the PowerArt™ will disengage the line.

### B. Executable Commands

**Attention!** For security reasons, every command in the following list is preceded by an asterisk [★] and a valid user code [Ⓢ].

Command	Keying Sequence
Disarming	[★]→[Ⓢ]→[1]
Arming <u>Home</u>	[★]→[Ⓢ]→[2]
Arming <u>Home-Instant</u>	[★]→[Ⓢ]→[21]
Arming <u>Away</u>	[★]→[Ⓢ]→[3]
Arming <u>Away-Instant</u>	[★]→[Ⓢ]→[31]
Arming <u>Away-Latchkey</u>	[★]→[Ⓢ]→[4]
Arming <u>Away-Instant-Latchkey</u>	[★]→[Ⓢ]→[41]
Activating electrical devices (1 - 7)	[★]→[Ⓢ]→[5]→[device No.]→[1]
Deactivating electrical devices (1 - 7)	[★]→[Ⓢ]→[5]→[device No.]→[0]
Activating the auxiliary output	[★]→[Ⓢ]→[5]→[8]→[1]
Deactivating the auxiliary output	[★]→[Ⓢ]→[5]→[8]→[0]
Recorded message playback	[★]→[Ⓢ]→[8]
Investigating system status	[★]→[Ⓢ]→[9]
Quit (end communication)	[★]→[9]→[9]

## 6.5 Two-Way Voice Communication

After establishing communication with the PowerArt™ from a remote telephone (see 6.3 A above), you may initiate a conversation with the person left within the residence by keying the following sequence on your telephone keypad:

[★] → [Ⓢ] → [7] → [3] ([Ⓢ] is your user code).

The system will start to function in the "LISTEN IN" mode, letting you hear the sounds within your residence for 50 seconds. If the person under surveillance happens to speak or cry then, you will hear this. However, to hold a two-way conversation, you must switch the system manually from **Listen-In** to **Speak Out** and back, as shown below:

For Function:	Press:
Listen-in (listening to the person at home)	[3]
Speak-out (speaking to the person at home)	[1]

**Note:** To prolong the communication session by 50 seconds, press [3] or [1] again, as required.

Unlike regular telephone conversations, in which you can interject a few words while the other party speaks, this system allows one way speech at a time. Back and forth exchange of uninterrupted speech between two parties is a method normally used in military, commercial and amateur radio communication. Once you finish talking you should say "Go Ahead" or "Over" and then switch from **Speak-out** to **listen in**. When the person at home finishes talking he should also say "Over", as a cue to you to switch back from **Listen-in** to **Speak out**.

**EXAMPLE:**

**You (at remote telephone):** [1], "Hey, George, can you hear me? Are you in any trouble? Over"..... [3]

**Person at home:** "Yes, I am. I had a dizzy spell while trying to get out of bed and fell on the floor. I am unable to get up and my thigh hurts. Can you help me? Over"...

**You (at remote telephone):** [1], "Sure, I will send someone right away, stay put - over"..... [3].

**Person at home:** "Thanks, please hurry, over."

**You (at remote telephone):** [1], "All right, over and out"..... [\*]→9]→9] (END OF SESSION)

**Important!** If you wish to exit the two-way communication mode and execute another command, just press [\*] and then key your user code followed by the command (see "keying sequences" in Para. 6.3 B above).

**6.6 Receiving Messages at a Remote Telephone**

The PowerArt™ can be programmed by the installer for selective transmission of messages to private telephone subscribers. Messages are divided by type into 3 groups:

Group	Events Reported
1	Fire, Burglary, Panic, Tamper
2	Arming AWAY, Arming HOME, Disarming
3	No-activity, Emergency, Latchkey

**Group 1** has the highest priority and group 3 has the lowest priority.

When the called party answers a call initiated by the PowerArt™, he will hear a verbal message composed of the "house identity" and the type of event that occurred. For example, once smoke is detected in the Smith residence, the message will be:

**[The Smith Residence - Fire Alarm].**

If a person under surveillance in the Watkins residence has been inactive, the message will be:

**[The Watkins Residence - No Activity].**

The called party must acknowledge the message (as explained later on), but if he does not respond, the message will be transmitted repeatedly as many times as possible within a 45-second time limit. When the 45 seconds are up, the PowerArt™ will disengage the line and call the next private telephone number on its list.

The called party can acknowledge the message by pressing a digit on the telephone keypad, as listed below:

Digit	Effect
2	<b>Acknowledge only:</b> The PowerArt™ disengages the line and considers the event duly reported.
3	<b>Acknowledge and listen-in:</b> The protected site is "bugged" for sound for 60 seconds. The called party may prolong the listening session by pressing [3] again before the PowerArt™ disengages the line, or by pressing [1] to speak.

1	<b>Acknowledge and speak out:</b> The called party may speak for 60 seconds to whoever is in the protected site. The called party may prolong the "speak out" session by pressing [1] again before the PowerArt™ disengages the line, or by pressing [3] to listen.
9	<b>Acknowledge and request a status report:</b> The PowerArt™ will issue a verbal report of system status. For example: [Disarm - ready to arm] or [Disarm - back door open] or [Disarm - alarm in memory].

**6.7 Receiving Messages Via a Pager**

Since the PowerArt™ can be programmed to report events to a pager, the user of the pager must be informed on how to interpret the numerical message that his pager displays. Communication with a pager takes place as follows:

- The PowerArt™ dials the pager's phone number, waits 5 seconds and sends the numerical message.
- The message transmitted by the PowerArt™ to the pager is actually a string of digits, as exemplified in Figure 8 below.

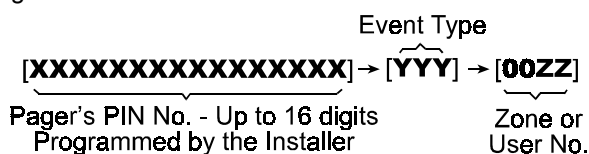

**Figure 8. Pager Message Structure**

The person receiving the message sees only the "YYY-00ZZ" part of the message, which he can interpret by using the following legend:

Events types (YYY) are coded as follows:

Event	Code	Event	Code
Alarm	919	Fire	515
Trouble	818	Close	101
Emergency	717	Open	102
Panic	616	Latchkey	103

**ZZ** is the zone number in which the event occurred, or the user number in case of Close, Open and Latchkey events.

**Example 1: Message reads "919-0003":**

This means an alarm occurred in Zone No. 3.

**Example 1: Message reads "101-0008":**

This means the system was closed (armed) by user No. 8.

**6.8 Conducting a Walk Test**

The walk test is an indispensable operation by which you verify that all detectors function properly, without disturbing the neighbors with loud sirens. The test must be performed **at least once a week**, and should include all detectors in all zones.

**Note:** During the test period, 24-hour zones will not cause an alarm if violated, but a fire zone will function normally.

A typical test will take place as follows:

**A.** Press the test button (🔑).

**B.** The display will prompt you for your user code:

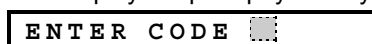

**C.** Enter your code. The siren will sound for 2 seconds and the display will change to:

TESTING

D. Walk throughout the protected area and make sure you trigger every detector with no exception (move across the field of view of motion detectors and open/close doors and windows). Each time a detector is triggered:

- The "Happy Tune" will sound,
- The zone name and number will be displayed briefly,

**EXAMPLE 1:** You triggered a **motion detector** in the ROOM 1 (zone 11). The display will show:

ROOM 1



Z11 Violated

After 5 seconds the display will revert to:

TESTING

**EXAMPLE 2:** You opened a **window** in room 2 (zone 13).

The display will show:

ROOM 2



Z13 Open

After 5 seconds the display will revert to:

TESTING

E. When done, click the button repeatedly. The display will show the test results, zone after zone, in ascending numerical order. For example:

ROOM 2

(alternating)

Z13 OK

or: "Z13 NOT OK" if there was no response from Z13.

F. To resume testing, click . To quit the test mode, click . The display will then read:

<OK> TO EXIT

G. Click . The display will revert to its normal state.

## 7. USER SETTINGS

### 7.1 What are the Settings You Need?

The installer provides you with a ready-to-use alarm system, almost entirely tailored to your requirements, but a few settings and adjustments will still be needed.

**Note:** Although the user settings are your responsibility, you may request your installer to perform them for you (except for the follow-me phone number, which you must re-program to follow your whereabouts, and user codes, which you would like to keep secret).

The user settings include:

- **Bypassing Zones** - determining which zones will be bypassed (disabled) throughout the present disarm period and the next armed period.
- **Reviewing the bypass list** - "show bypass" - displaying the numbers and names of bypassed zone one by one.
- **Recalling the last bypassing scheme** - "recall bypass" - re-using the previous bypassing scheme, which becomes suspended after disarming but is still saved in the PowerArt™ memory.
- **Programming the "follow-me" (4th) telephone number\*** - recording the number at which you can be reached while being away. The PowerArt™ will call this number to report the event types defined by the installer.
- **Setting user codes\*** - programming a security code for yourself and additional 7 codes for other system users. Codes 5 through 8 are "Latchkey" user codes (see Para. 2.9 for additional details).
- **Setting voice options\*** - selecting between verbal announcements and no verbal announcements.
- **Setting the time\*** - adjusting the built-in clock to show the correct time.
- **Setting the date\*** - adjusting the built-in calendar to show the correct date.

\* Settings marked with an asterisk are accessible to the master user only. This means that when entering the USER SETTINGS mode with a regular user code, the only accessible functions are the first 3 on the list.

### 7.2 Entering the User Settings Menu

When the system is in the disarmed state, and all zones are secured (undisturbed), the display will read:

READY 00:00

The 00:00 or any other digits on display show the present time (hours : minutes).

To enter the user settings menu, proceed as follows:

Action	Resultant Display	Sound
	NORMAL MODE	♪
	USER SETTINGS	♪
	ENTER CODE [ ]	♪
[ wrong ]	ENTER CODE [ ]	☹
[ valid ]*	SET BYPASS	☺

\* If this is the first time you open this menu, use the default master code: 1 1 1 1.

If you do not wish to bypass any zone just now, you may click <NEXT> repeatedly to select any other programmable function as shown in Figure 9 below:

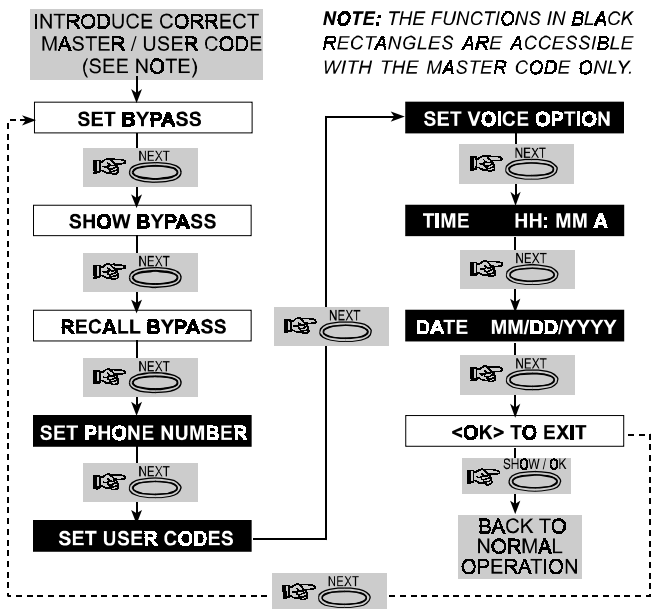

Figure 9. Moving About in the User Settings Menu

When you reach **<OK> TO EXIT**, you may click **SHOW/OK** to quit the USER SETTINGS menu and revert to the normal operating mode.

When keying digits, clicking **<BACK>** will move the cursor one digit to the left (without erasing), clicking **<NEXT>** will move it one digit to the right and clicking **<OFF>** will delete everything to the right of the cursor. If you do not press any key for 4 minutes, the system will automatically quit the USER SETTINGS menu.

### 7.3 Bypassing Zones

#### A. General Guidance

You can program the PowerArt™ to exclude (bypass) selected zones, regardless of whether these zones are "functional" (undisturbed) or "open" (disturbed). Bypassing permits free movement of people within certain zones although the system is armed. It is also used to temporarily remove from service faulty zones that require repair work. **Fire zones can not be bypassed.**

**Remember – zone bypassing compromises security!**

Zone bypassing must be carried out while the system is in the disarmed state.

**Note:** Zones will be bypassed throughout one disarm-arm period only. Disarming the system after arming will suspend the entire bypassing scheme, which can be recalled later if so desired.

#### B. Bypassing Procedure

Having entered your user code successfully (see Para. 7.2), the display will read:

SET BYPASS

If at this point you click **<SHOW/OK>**, the number, state and name of the first zone will be automatically displayed. Three states are possible:

- **Open:** The zone is not secured - you can bypass it if you do not wish or know how to solve the problem just now.
- **Bypassed:** The zone is presently bypassed (you bypassed it before but haven't armed the system yet).
- **Functional:** If there is nothing wrong with the zone, its state is described as "Functional".

Let us assume that Zone 1 is "open" and you wish to bypass it, and the rest of the zones are functional.

Action	Resultant Display	Sound
<b>SHOW/OK</b> 	Z 0 1 : O P E N (alternating) GALLERY 1	♪
<b>SHOW/OK</b> 	<OK> TO BYPASS	♪
<b>SHOW/OK</b> 	Z 0 1 : B Y P A S S E D (alternating) GALLERY 1	😊
<b>NEXT</b>  (If you wish to check the state of the next zone)	Z 0 2 : F u n c t i o n a l (alternating) ROOM 1	♪
<b>HOME</b> 	SET BYPASS	

You may now select any other item on the USER SETTINGS menu or quit programming by clicking **<AWAY>**. When **<OK> TO EXIT** is displayed - click **<OK>**.

After concluding the bypassing operation, **Bypass** blinks in the display:

READY BYPASS or NOT READY BYPASS

This indication will persist as long as the system remains disarmed, and will disappear once the system is armed.

**Note:** **Bypass** will alternate in the display with other messages, as the case may be: **Trouble**, **Memory** and **Message**.

#### C. "Unbypass" Procedure

Suppose you wish to restore a zone to service after having completed the bypassing scheme. Simply re-enter the SET BYPASS menu (see Para. 7.3B above), and click **<NEXT>** or **<BACK>** until the zone you wish to "unbypass" is on display. Here is an example of the following steps:

Action	Resultant Display	Sound
<b>NEXT</b> 	Z 2 2 : B y p a s s e d (alternating) ROOM 1	♪
<b>SHOW/OK</b> 	<OFF> TO CLEAR	♪
<b>OFF</b> 	Z 2 2 : F u n c t i o n a l (alternating) ROOM 1	😊

You may now click **<HOME>** and then select any other item on the USER SETTINGS menu, or click **<AWAY>** to quit programming. When **<OK> TO EXIT** appears - click **<OK>**.

#### 7.4. Reviewing the Bypassed Zone List

Having entered your user code successfully (see Para. 7.2), the display will read:

SET BYPASS

Click **<NEXT>** to change the display into:

SHOW BYPASS

Click **<SHOW/OK>** to change the display into:

BYPASS LIST

If at this point you click **<SHOW/OK>**, the number, state and name of the first **bypassed** zone will be displayed.

You can now click **<NEXT>** repeatedly to review all



bypassed zones, in ascending numerical order. When done, clicking <HOME> will get you back to **SHOW BYPASS** and clicking <AWAY> will get you back to <OK> TO EXIT.

## 7.5 Recalling the Last Bypass Scheme

Arming the alarm system with several zones in the bypassed state is in fact "partial arming". An identical partial arming may be repeated by recalling the last bypassing scheme (that was suspended and memorized upon disarming the system).





Having entered your user code successfully (see Para. 7.2), the display will read:

SET BYPASS

Click <NEXT> twice to change the display into:

RECALL BYPASS

At this point proceed as follows:

Action	Resultant Display	Sound
	<OK> TO RECALL	
	RECALL BYPASS	







You may now select any other item on the USER SETTINGS menu or quit programming by clicking <AWAY>. When <OK> TO EXIT is displayed - click <OK>.

## 7.6 Programming the "Follow-me" Telephone Number

Having entered your Master Code successfully (see Para. 7.2), the display will read:

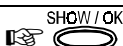
SET PHONE NUMBER

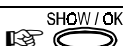
Please note that the 1<sup>st</sup>, 2<sup>nd</sup> and 3<sup>rd</sup> private telephone numbers are programmed by the installer. You are allowed to program the 4<sup>th</sup> ("follow-me") number as follows:

Action	Resultant Display	Sound
	[ ]	
	XXXXXXXXXX [ ]	
	XXXXXXXXXX	
	SET PHONE NUMBER	

You may now switch to any other item on the USER SETTINGS menu or quit programming by clicking <NEXT> until <OK> TO EXIT is displayed and then clicking <OK>.

## 7.7 Setting the User Codes

Having entered your Master Code successfully (see Para. 7.2), click <NEXT> until the display reads:

SET USER CODES

Please note that:

**User Code 1** replaces the factory default master code, and should be assigned to the master user of the system. This code can not be erased.











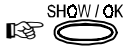

**User Codes 2, 3 and 4** can be assigned to additional users - family members, co-workers etc.

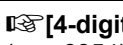
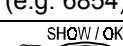
**Codes 5 through 8** are assigned to "Latchkey Users" (see Para. 2.9 for explanation of the latchkey mode).

**CAUTION! Code "0000" is not valid! Do not use it.**

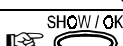
**Note:** The duress code set by the installer (2580 by default) cannot be selected as a normal user code. Any attempt to program it will be rejected by the PowerArt™.

To program the codes, proceed as follows:

Action	Resultant Display	Sound
	user code1 [ ]	
	user code1: 0:000	
	user code1: 6854	
	user code1: 6854	
	user code2	
Continue the same way up to Code 8.		
	user code8: 5537	
	SET USER CODES	

You may now select any other item on the USER SETTINGS menu or quit programming by clicking <AWAY>. When <OK> TO EXIT is displayed - click <OK>.

## 7.8 Setting the Voice Options

**Remember:** Voice prompts are heard over the built-in loudspeaker subject to two conditions:

- The voice option is enabled as shown below
- The loudspeaker is enabled by pressing the "7" key (see Para. 3.3)

The following procedure allows you to select one of two options:

- **Enable prompts:** Voice announcements
- **Disable prompts:** No voice announcements







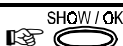

The presently programmed option will be shown, with a dark selection box (■) at the far right of the display. You may view the other option (that does not have a dark box at the far right) by clicking <NEXT>. A dark box will appear if you click <OK> while the other option is displayed.

To set the voice option, proceed as follows:

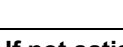
Having entered your Master Code successfully (see Para. 7.2), click the <NEXT> button until the display reads:

SET VOICE OPTION

From here, proceed as follows:

Action	Resultant Display	Sound
	enable prompts ■ (if this is the current option)	
	disable prompts	
	disable prompts ■	
	SET VOICE OPTION	

You may now select any other item on the USER SETTINGS menu or quit programming by clicking <AWAY>. When <OK> TO EXIT is displayed - click <OK>.

## 7.9 Setting the Clock

Having entered your Master Code successfully (see Para. 7.2), click <NEXT> until the display reads:

TIME            HH:MM A

From here, proceed as follows:

Action	Resultant Display	Sound
SHOW / OK	TIME 00:00 A	♪
[time digits] (e.g. 12:55 A)	TIME 12:55 A	
SHOW / OK	TIME 12:55 A	♪
SHOW / OK	TIME HH:MM A	😊

**Note:** To enter "A" - press [\*] and to enter "P" - press [#]. You may now select any other item on the USER SETTINGS menu or quit programming by clicking <AWAY>. When <OK> TO EXIT is displayed - click <OK>.

## 7.10 Setting the Date

Having entered your Master Code successfully (see Para.

7.2), click <NEXT> until the display reads:

DATE MM/DD/YYYY

Proceed as follows to set the date (in MM/DD/YY format):

Action	Resultant Display	Sound
SHOW / OK	DATE 01/01/2000	♪
[date] (e.g. March 14, 2000)	DATE 03/14/2000 (for the year, enter only the last two digits)	
SHOW / OK	DATE 03/14/2000	♪
SHOW / OK	DATE MM/DD/YYYY	😊

You may now select any other item on the USER SETTINGS menu or quit programming by clicking <AWAY>. When <OK> TO EXIT is displayed - click <OK>.

## 8. READING THE EVENT LOG

### 8.1 Event Log Description

All events are memorized in an event log that contains up to 100 entries. You can access this log, review the events one by one and draw functional conclusions.

If the event log fills up completely (the number of registered events reaches 100) it continues to accept new events at the expense of old events - the oldest event is deleted upon registration of each new event.

The date and time of occurrence are memorized for each event. When reading the event log, events are shown in chronological order - from the newest to the oldest.

Because of the limited display space, the event description is shown first, then the date and time. The two displays are shown alternately several times, until you click <OK> to move on to an older event, or until the "no action" 4-minute timeout restores the system to the normal operating mode.

Access to the event log is provided by clicking the asterisk (\*) key and then keying your master code.

**Should you wish to get an overall view of using the log, refer to Figure 10. The chart there may even serve as your only guide to using the event log, instead of going through the written step-by-step procedure.**

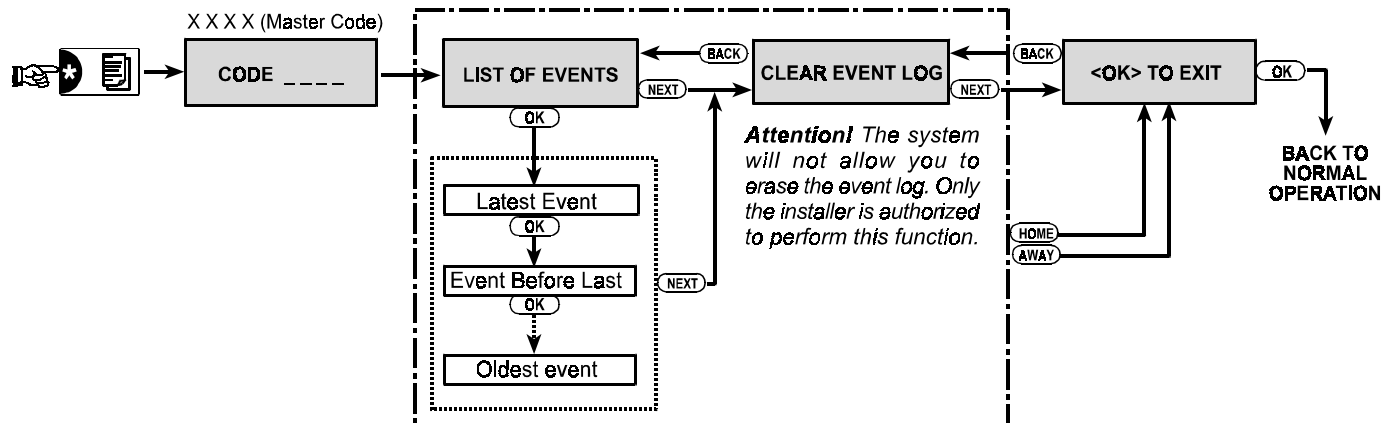

Figure 10. Using the Event Log

### 8.2 Reading Procedure

To read the event log, proceed as follows:

A. While the system is in the normal operating mode, click the asterisk (\*) key. The display will change to:

CODE \_ \_ \_ \_

B. Enter the current master code. If the code is correct, the "Happy Tune" will sound and the display will read:

LIST OF EVENTS

**Important!** Entering an incorrect code 5 times in a row will initiate a 30-second penalty lockout of the keypad.

C. Click <OK>. The latest event will be shown. Suppose that the latest event was an alarm in zone 13. The display will now read:

Z 13 ALARM

and then:

09/02/99 3:37P

The two displays will be shown alternately until you click <OK> again to move to the next event, or until the event log times out (4 minutes).

D. Click <OK> as many times as necessary to read all the data you need.

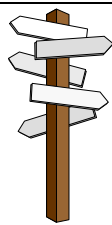

To quit the event log:

- Click <HOME> or <AWAY> from anywhere within the log. The display will read:

<OK> TO EXIT

- Click <OK>. The system will return to the normal operating mode.

## 9. MAINTENANCE

### 9.1 Replacing the Backup Battery

The PowerArt™ operates from the regular electrical supply of the protected site, but incorporates an internal 9-Volt battery that keeps it working during power failures. It is extremely important to maintain this battery in good condition, namely to replace it immediately upon getting the following trouble message when reviewing system troubles (see Para. 5.2B):

#### CPU LOW BATTERY

Replacing the battery is a relatively simple process, so you do not have to bother your installer. Proceed as follows:

- A. Prepare 6 AA-size alkaline battery cells (option 1) or 6 size AA, 650 mA/h Nickel-Cadmium cells (option 2) - purchased in any hardware or electrical supply store.
- B. Make sure that the keypad cover is open.
- C. Insert a wide bladed screwdriver into the slot shown in Figure 11, and turn the handle slightly to force the right edge of the left-hand cover up. This should dislodge the two catches and free the right edge of the cover.

**Warning! Do not try to dislodge the left side of the cover first! This will break the angled legs at the left.**

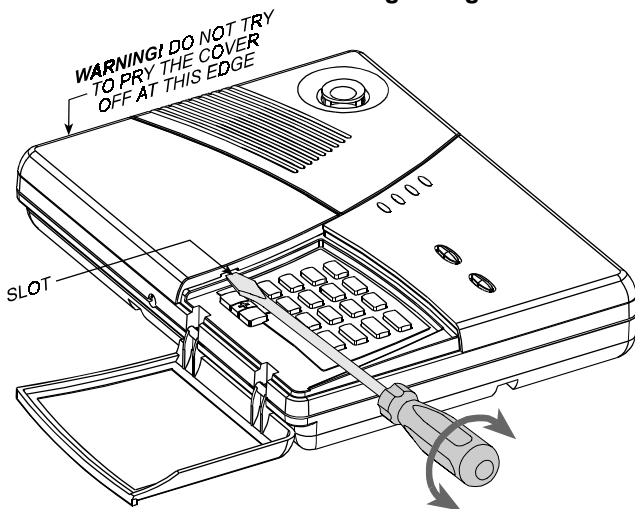

Figure 11. Prying the Cover Loose

- D. Swing the cover up as shown in Figure 12, then pull free the angled legs at the left and put the cover away. The inner lid will now be in full view (see Figure 13).

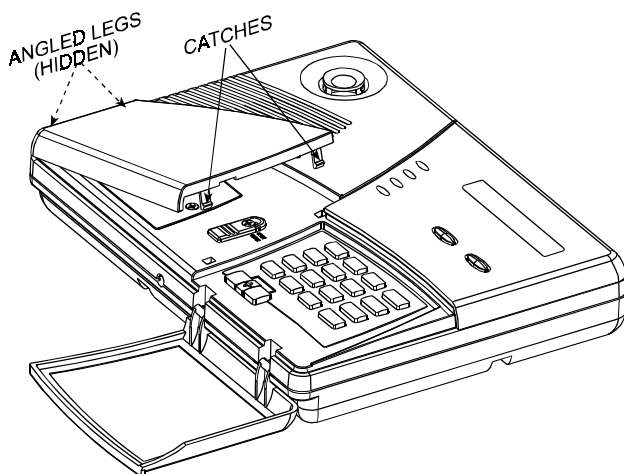

Figure 12. Removing the Left Hand Cover

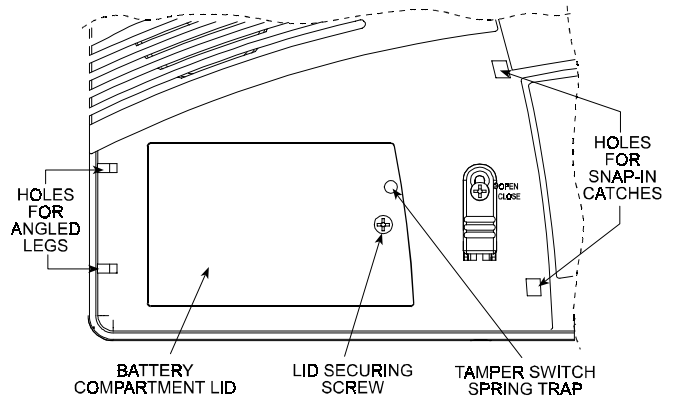

Figure 13. Battery Compartment Lid

- E. Remove the screw that secures the battery compartment lid (Fig. 13), swing the lid up and pull it away. You have thus gained access to the battery holder (see Fig. 13).

**ATTENTION!** Removal of the lid will start a "tamper" alarm - the trouble indicator will light and both "memory" and "trouble" will flash in the display window. If you interrogate the system at this stage by clicking the <OK> button, "CPU TAMPER ALARM" and "CPU TAMPER OPEN" will be displayed, in addition to "CPU LOW BATTERY".

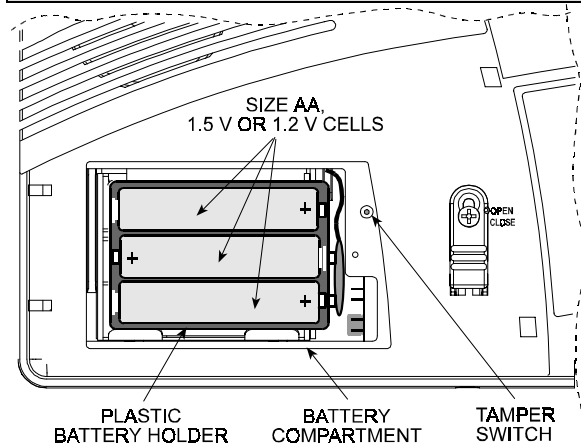

Figure 14. Battery Compartment and Battery Holder

- F. Pull the battery holder out and replace all 6 battery cells - 3 at the top and 3 at the bottom. Make sure that the flat (negative) end of each cell is pressed against a circular spring and the capped (positive) end of each cell is pressed against a flat contact.



**CAUTION!** If you replace rechargeable cells with alkaline (dry) cells or vice versa, mount the battery-type selector in the correct position (CHRG for rechargeable cells and DRY for alkaline cells - see Figure 15).

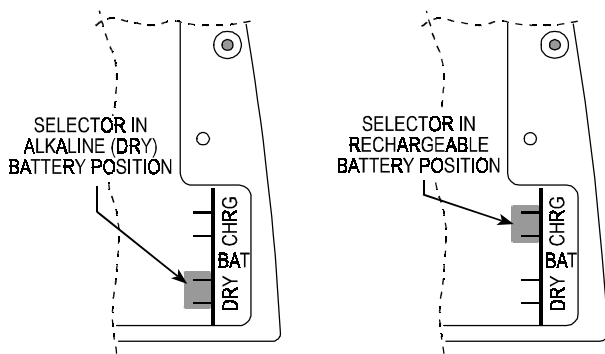

Figure 15. Battery Selector Positions

- G. Put the battery holder back in, re-mount the battery compartment lid and re-attach it with the screw. With correctly inserted fresh batteries and tight closure of the lid, the TROUBLE indicator should extinguish.
- H. Put back the battery area cover - insert the angled legs at the left edge into their holes and then press the right edge of the cover against the cabinet surface until the catches click into place.
- I. The "MEMORY" message will continue blinking in the display (caused by the "tamper" alarm you triggered). Clear it by arming the system and disarming it as soon as the exit delay starts.

## 9.2 Replacing Batteries in Wireless Devices

The **wireless sensors** supplied with your system are powered by high-capacity 3.6-Volt lithium batteries (Tadiran TL-5902) that last several years, depending on the number of times the sensor is triggered into transmission. The SPD-1000 artwork protection detector is powered by two 3V/160 mA long life (5 years) Lithium batteries.

However, if and when a battery becomes weak, the sensor itself sends a "low battery" message to the control panel, and a low battery trouble message is displayed together

with the zone information (see Para. 5.2).

The **keyfob transmitters** used to control the system are powered by a 12 V alkaline battery (type A27) that lasts about one year if you do not press a button more than 10 times a day. Battery exhaustion is clearly evident by flashing of the transmitter's red indicator while the button is pressed (instead of lighting steadily).

When a low battery indication appears for the first time, it may be considered as a pre-warning. It normally gives you ample time (about 30 days) to obtain a new battery and replace the old one, and the detector or keyfob unit will be fully operational throughout this period. However, to be on the safe side, it is advisable not to wait that long.

Use the battery specified in the detector's own installation instructions. If you do not have the instructions, seek the advice of your installer or ask him to replace the battery in the specific device that sent the low battery message.

After battery replacement, the detector unit will send a "battery restored" signal to the control panel, and the "low battery" message will be cleared.

## 9.3 Periodic Testing

The components of your security system are designed to be maintenance-free as much as possible. Nevertheless, it is mandatory to perform a "walk test" at least once a week and after an alarm event to verify that all system detectors function properly. Proceed as described in Para. 6.7, and if there is any problem, notify your installer at once.

## 9.4 Cleaning the Control Panel

The control panel may occasionally get stained if touched with greasy fingers, and may accumulate dust after a long period of use. Clean it only with a soft cloth or sponge moistened lightly with a mixture of water and mild detergent, and then wipe it dry.

**The use of abrasives of any kind is strictly forbidden. Also never use solvents such as kerosene, acetone or thinner. These will certainly ruin the external finish and damage the transparency of the top window.**

## 10. PERFORMANCE LIMITS

Although the alarm control system you purchased is highly reliable, it does not guarantee protection from burglary and fire hazards. Even the most advanced systems can be defeated or might occasionally fail to warn. Some of the reasons for this are:

**Sloppy maintenance:** If the system is used over a long period of time without testing, a key element such as a detector or a siren might go wrong without any visible or audible signs of failure. If a low battery warning is neglected, there will be no backup power to keep the system operational during a power outage.

**Power failures:** In case of prolonged absence from the protected site, the mains supply may suddenly fail (an earth leakage protection relay may trip, disconnecting the mains supply). After such an event, the alarm system will draw power from the backup battery, until all reserve power is exhausted, leaving the premises without protection.

**Telephone line trouble:** Telephone lines may be disconnected or short circuited. With the telephone line "down", your alarm system will not be able to report events to the central station.

**Sirens do not always wake up sound sleepers:** Sirens and bells installed outside or far from bedrooms are not likely to awaken people who are sound asleep behind closed doors inside the protected area or in adjacent buildings.

**The system is sometimes defeated:** With sufficient technical know-how, intruders may find a way to defeat various types of sensor or disconnect warning devices. Intruders may also take advantage of unprotected openings and skylights, or even enter forcibly at unpredictable spots.

**Smoke detectors have their limits:** In many cases, smoke detectors fail to warn on time because the fire started at a different level of the house, or too far away from the detector.

**All this gives sufficient proof that even with a good alarm system installed, there is still need for life and property insurance. In addition, users should test their alarm systems at regular intervals, to make sure that malfunctions are detected before a true alarm event occurs.**

## APPENDIX A. GLOSSARY

This list of terms is arranged in alphabetical order. Any term indicated by *cursive (italic) letters* within the explanatory text can be looked up separately.

**Arming:** Arming the alarm system is an action that prepares it to sound an alarm if a zone is "violated" by motion or by opening a door or window, as the case may be. The control panel may be armed in various modes (see *AWAY*, *HOME*, *INSTANT* and *LATCHKEY*).

**Abort Period:** When an alarm is initiated, the internal sounder is activated first for a limited period of time which is the abort period set by the installer. If you cause an alarm accidentally, you can disarm the system within the abort period before the real sirens start and before the alarm is reported to the *remote responders*.

**Alarm:** There are 2 kinds of alarm:

Loud alarm - both internal and external sirens blare out constantly and the control panel reports the event by telephone.

Silent alarm - the sirens remain silent, but the control panel reports the event by telephone.

A state of alarm is caused by:

- Motion detected by a *motion detector*
- Change of state detected by a *magnetic contact detector* - a closed window or door is opened
- Detection of smoke by a *smoke detector*
- *Tampering* with any one of the detectors
- Pressing the two emergency buttons simultaneously (panic)

**AWAY:** This type of arming is used when the protected site is vacated entirely. All zones, *interior* and *perimeter* alike, are protected.

**Chime Zones:** allow you to keep track of activity in the protected area while the alarm system is in the disarmed state. Whenever a chime zone is "opened", the buzzer beeps twice. The buzzer doesn't beep, however, upon closing the zone (return to normal). Residences can use this feature to announce visitors or look after children. Businesses can use it to signal when customers enter the premises or when personnel enter restricted areas.

**Note:** *Your installer will never designate a 24-hour zone or a fire zone as a chime zone, because both zone types actuate an alarm if disturbed while the system is in the disarmed state.*

Although one zone or more are designated as chime zones, you can still enable or disable the chime function.

**Control Panel:** The control panel is a cabinet that incorporates the electronic circuitry and microprocessor that control the alarm system. It collects information from various sensors, processes it and responds in various ways. It also includes the user-interface - control keys, numerical keypad, display, sounder and loudspeaker.

**Disarming:** The opposite of arming - an action that restores the control panel to the normal standby state. In this state, only *fire and 24-hour zones* will sound an alarm if violated, but a "*panic alarm*" may also be initiated.

**Disturbed Zone:** A zone in a state of alarm (this may be caused by an open window or door or by motion in the field of view of a motion detector). A disturbed zone is considered "not secured".

**Forced Arming:** When any one of the system zones is *disturbed* (open), the alarm system cannot be armed. One way to solve this problem is to find and eliminate the cause for zone disturbance (closing doors and windows). Another way to deal with this is to impose **forced arming** - automatic de-activation of zones that are still *disturbed* upon termination of the exit delay. Bypassed zones will not be protected throughout the arming period. Even if restored to normal (closed), bypassed zones will remain unprotected until the system is disarmed.

Permission to "force arm" is given or denied by the installer while programming the system.

**HOME** - This type of arming is used when people are present within the protected site. A classic example is night-time at home, when the family is about to retire to bed. With HOME arming, perimeter zones are protected but interior zones are not. Consequently, motion within interior zones will be ignored by the control panel, but disturbance of a perimeter zone will cause an alarm.

**Instant:** You can arm the system AWAY-INSTANT or HOME-INSTANT, thereby canceling the entry delay for all delay zones for the duration of one arming period.

For example, you may arm the control panel in the HOME-INSTANT mode and remain within the protected area. Only perimeter protection is active, and if you do not expect somebody to drop in while the system is armed, alarm upon entry via the main door is an advantage.

To disarm the system without causing an alarm, use your control keypad (which is normally accessible without disturbing a perimeter zone) or use a keyfob transmitter.

**Magnetic Contact Detector, Wireless:** A Magnet-controlled switch and a wireless PowerCode transmitter in a shared housing. The detector is mounted on doors and windows to detect changes in state (from closed to open and vice versa). Upon sensing that a door or window is open, the detector transmits its unique identification code accompanied by an "alarm" signal and various other status signals to the control panel. The control panel, if not armed at that time, will consider the alarm system as "not ready for arming" until it receives a "restored" signal from the same detector.

**Motion Detector, Wireless:** A passive Infrared motion sensor and a wireless PowerCode transmitter in a shared housing. Upon sensing motion, the detector transmits its unique identification code, accompanied by an alarm signal and various other status signals to the control panel. After transmission, it stands by to sense further motion.

**Non-Alarm Zone:** Your installer can designate a zone for roles other than alarm. For instance, a motion detector installed in a dark stairway may be used to switch on lights automatically when someone crosses the dark area. Another example is a miniature wireless transmitter linked to a zone that controls a gate opening mechanism.

**Quick Arming:** Arming without a user code. The control panel does not request your user code when you press one of the arming buttons. Permission to use this arming method is given or denied by the installer while programming the system.

**Remote Responder:** A responder can be either a professional service provider to which the home or business owner subscribes (*a central monitoring station*) or a family relation/friend who agrees to look after the

protected site during absence of its occupants. The *control panel* reports events by telephone to both kinds of responders.

**Restore:** When a detector reverts from the state of alarm to the normal standby state, it is said to have been “restored”.

A *motion detector* restores automatically after detection of movement, and becomes ready to detect again. This kind of “restore” is not reported to the remote *responders*.

A *magnetic contact detector* restores only upon closure of the protected door or window. This kind of “restore” is reported to the remote *responders*.

**Smoke Detector, Wireless:** A regular smoke detector and a wireless PowerCode transmitter in a shared housing. Upon detection of smoke, the detector transmits its unique identification code accompanied by an alarm signal and various status signals to the *control panel*. Since the smoke detector is linked to a special *fire zone*, a fire alarm is initiated.

**User Codes:** The PowerArt™ is designed to obey your commands, provided that they are preceded by a valid security access code. Unauthorized people do not know this code, so any attempt on their part to *disarm* or defeat the system is bound to fail. Some operations, however, can be carried out without a user code as they do not degrade the security level of the alarm system.

**Zone:** A zone is an area within the protected site under supervision of a specific detector. During programming, the installer allows the *control panel* to learn the detector’s identity code and links it to the desired zone. Since the zone is distinguished by number and name, the control panel can report the zone status to the user and register in its memory all the events reported by the zone detector. Instant and delay zones are “on watch” only when the control panel is armed, and other (*24-hour zones*) are “on watch” regardless of whether the system is armed or not.

**NOTES:**

A series of approximately 35 horizontal dotted lines intended for handwritten notes.



**VISIONIC LTD. (ISRAEL):** P.O.B 22020 TEL-AVIV 61220 ISRAEL. PHONE: (972-3) 645-6789, FAX: (972-3) 645-6788  
**VISIONIC INC. (U.S.A.):** 10 NORTHWOOD DRIVE, BLOOMFIELD CT. 06002-1911. PHONE: (860) 243-0833, (800) 223-0020. FAX: (860) 242-8094  
**VISIONIC LTD. (UK):** FRASER ROAD, PRIORY BUSINESS PARK, BEDFORD MK44 3WH. PHONE: (0870) 7300800 FAX: (0870) 7300801  
**INTERNET:** [www.visonic.com](http://www.visonic.com)

©VISIONIC LTD. 2001 POWERART DE5458U (REV. 0, 9/01)

